

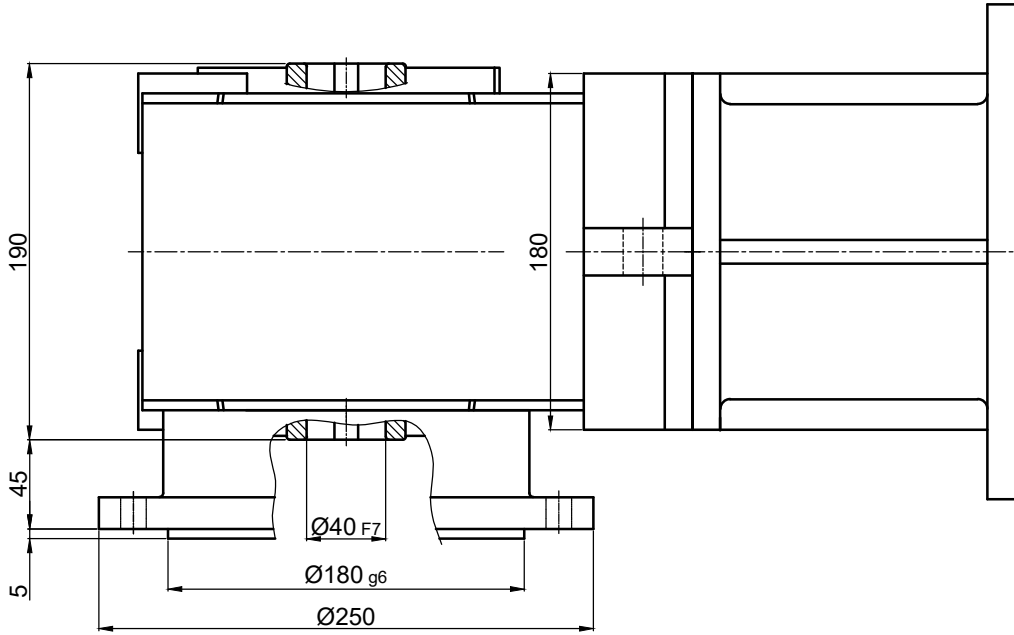

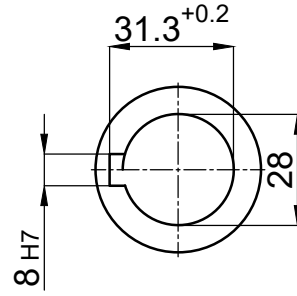

Dönüş Yönü
Rotation Direction

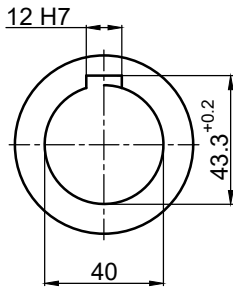
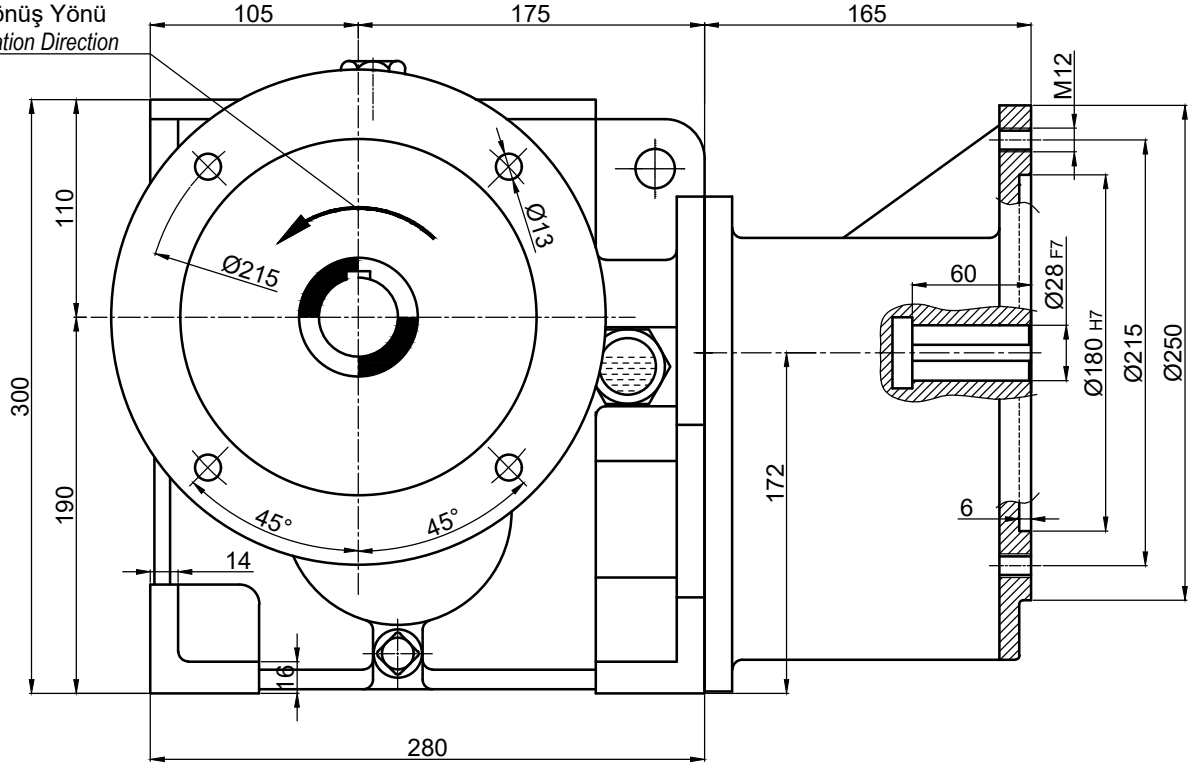

İsim / Name		Tarih / Date	HELİSEL VE KONİK DİŞLİLİ, MİLE GEÇME , IEC B5 FLANŞLI MOTOR ADAPTÖRLÜ, FLANŞLI , MOTORSUZ , KİLİTLİ REDÜKTÖR HELICAL-BEVEL GEAR UNITS, SHAFT , FLANGE MOUNTED, WITH IEC B5 MOTOR ADAPTER WITHOUT MOTOR , WITH BACKSTOP			
Çizen / Drawer			Resim No / Drawing No	DZGNF3-100/112		
Kontrol / Control			Malzeme / Material	-	Adet / Quantity	-
Onay / Approve	-	-				Ölçek / Scale -   A4